

HIGH TECHNOLOGY  
CREATIVE ART  
INDUSTRIAL DESIGN STUDIO

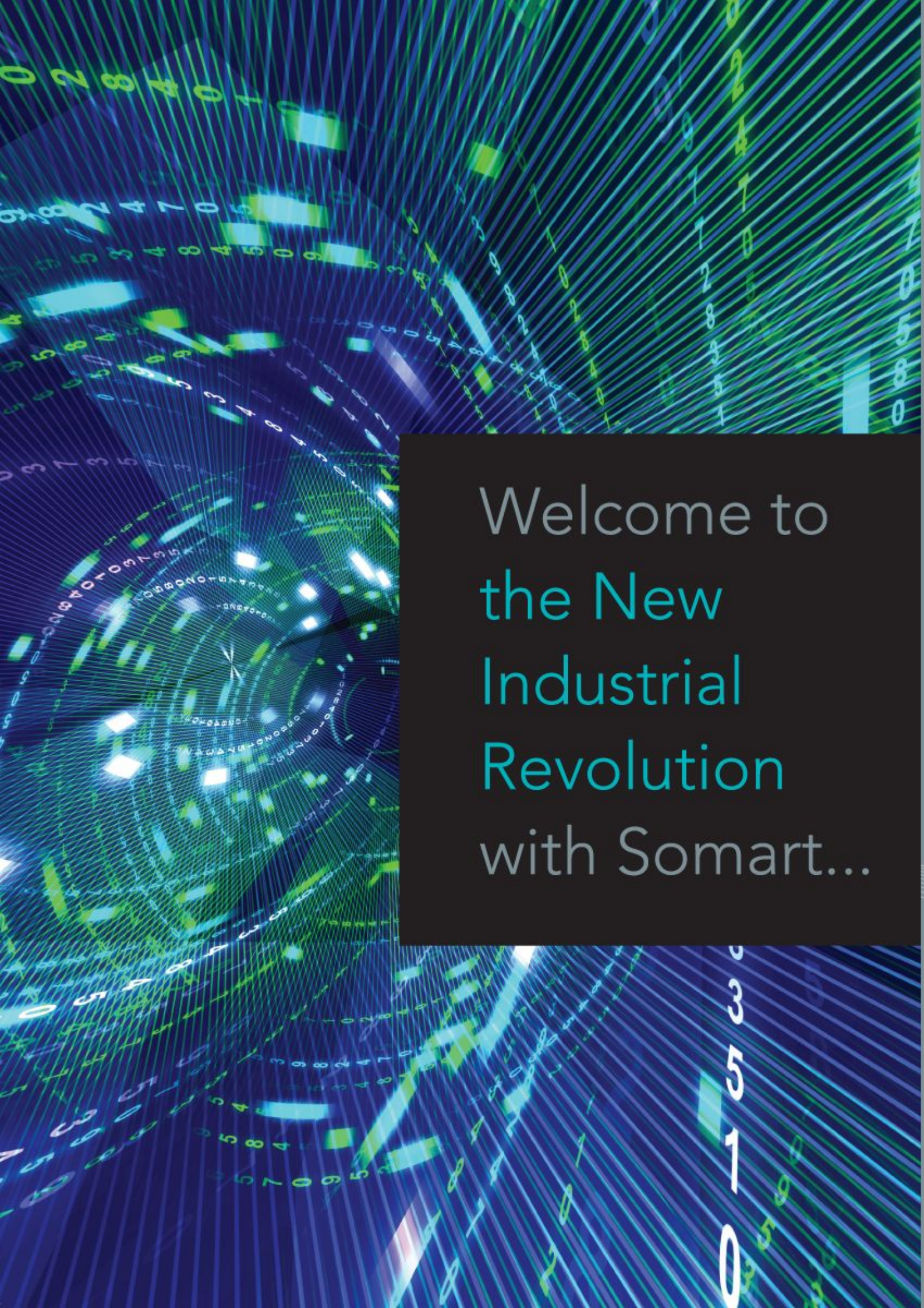

**SOM**  
**ART**  
**TECH**

**THINK  
BIG**  
*with*  
**HIGH  
TECH**



Welcome to  
the New  
Industrial  
Revolution  
with Somart...



ur company was  
founded in 2008  
and restructured in

2011 with the name SOMART Visual and  
Industrial Design LLC to better serve the  
needs of the industry.

## SomartTECH is a solution partner company.

We offer high-end, high quality, fast,  
efficient and affordable solutions in many  
fields; functional & visual modeling,  
prototype production, mold design,  
reverse engineering services and  
manufacturing solutions to mass  
production.

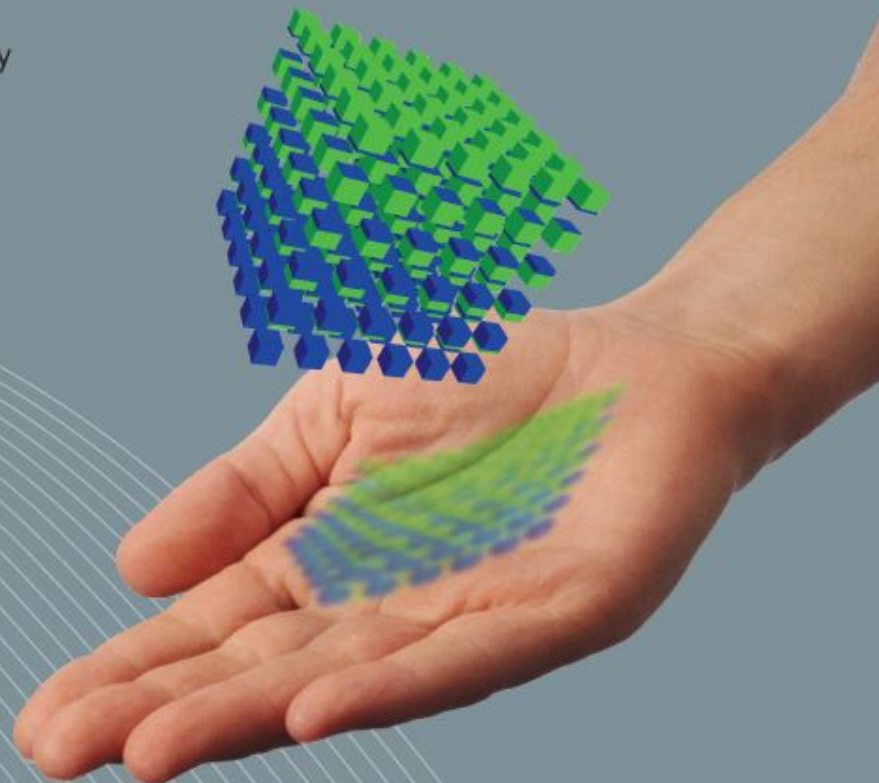

We make special investments to shorten every kind of product development process in terms of prototype, model and mold production. We offer services to the industry by processing volumes up to 700 x 400 x 200 cm with its 8-axis octatron robot CNC, 5-axis CNC with one of the fastest machines in Turkey.

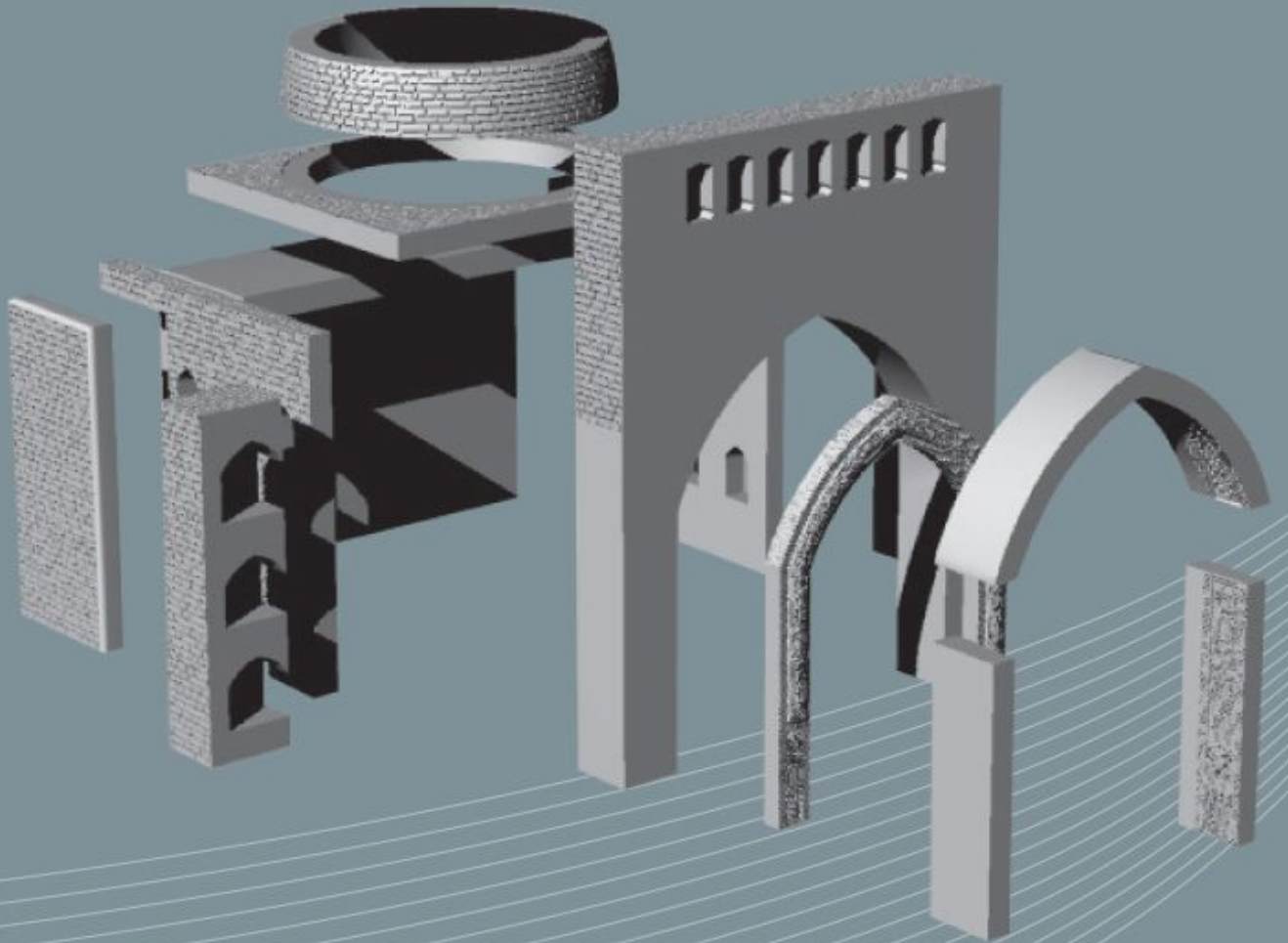

Our headoffice and factory are located in Istanbul Tuzla Organized Industrial Zone. We manufacture ABS, CTP, RTM, PU, SMC molds and models for many subsidiary industries in Turkey – automotive, aerospace, construction, building materials, private yacht, museum industry, water parks, theme parks, pool systems etc.

It's not a dream...

Extraordinary projects  
come to life in short  
periods of time.

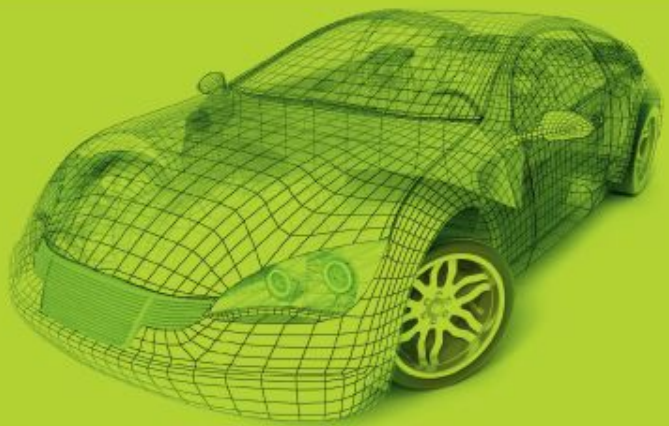

A close-up photograph of a man's face, focusing on his blue eyes and brown beard. The image is partially obscured by a dark, semi-transparent rectangular box containing text. The background is a solid black color. The man's face is the central focus, with his eyes looking slightly to the right. The beard is thick and brown, framing the lower part of his face. The skin is fair and has a natural texture. The text is centered within the dark box and is written in a clean, sans-serif font. The overall composition is a close-up portrait with a professional and creative feel.

Outstanding  
solutions  
for creative  
expectations

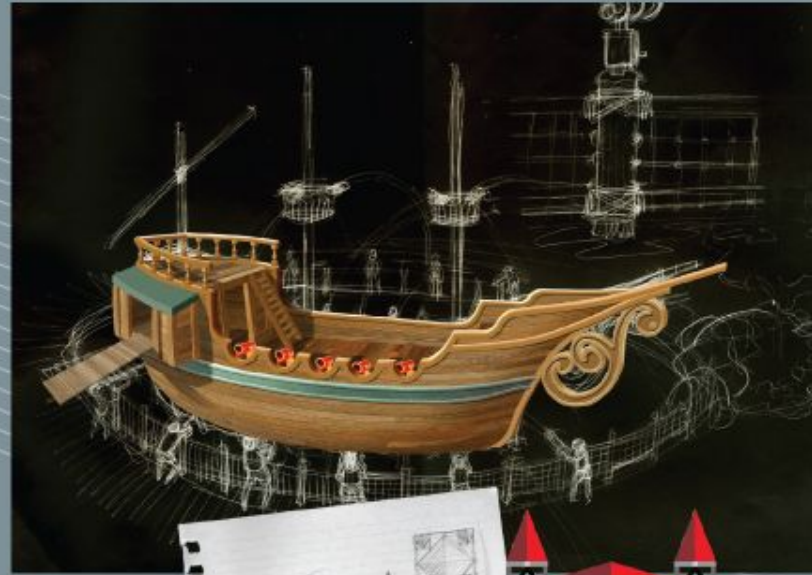

We team up with our customers as their solution partner. Alongside with the production process, we provide consultancy from the initial point to the completion of the project. These works are carried out by in-house art consultants, sculptors and expert technical operators.

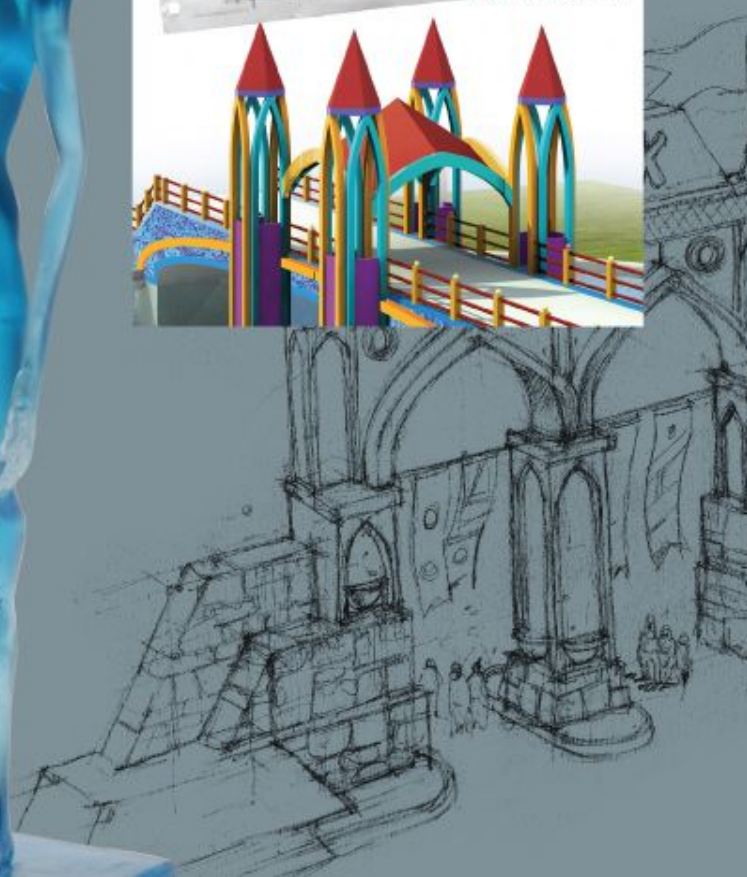



Experienced team  
and **high technology**  
are together  
to provide you  
the best service...







Our factory utilizes the most advanced manufacturing equipment and procedures. From concept to completion, we enforce strict quality control standards.



#### **5- AXIS CNC MACHINE**

An 5-Axis CNC machine, for large scale plug and mold production, lies at the heart of the SomartTECH.

The superior skills of this machine combined with the expertise of our edesign and engineering team ensures first-class quality and craftsmanship on our tooling projects.

#### **8- AXIS CNC MACHINE**

An 8-Axis CNC machine is used for superior artistic works by multi-functional structure.





## Product Range



### **TOOLING SERVICES**

We aim to add value to our customers by offering them engineering and manufacturing support for plugs, patterns and high-quality tooling that are both productive and cost efficient.

### **PROTOTYPING SERVICES**

In addition to our tooling services, we also provide prototype services for our customers.

Prototyping provides significant advantages, including; lowering the cost and risks of the project, prompt visualization of the outcome and the ability to work for the refinement until all manufacturing goals are met. We also prepare a dimensional verification report on demand, to ensure the accuracy of our work.

### **PATTERN AND PLUG PRODUCTION SERVICES**

Main pattern production consists of a wooden or foam-based structure laminated with fiberglass, followed by an application of epoxy model paste. The epoxy model paste is processed to form the final surface prior to completion. A premier and top coat are applied, sanded, and polished to achieve the desired surface finish.



Museum  
Concepts / Designs  
Realizations

Urban  
Products

Industrial  
Products

Theme Parks  
Children  
Play Areas

**OUTSTANDING  
ENGINEERING SERVICES**

- CAD design & CAM programming
- Reverse engineering
- Prototyping
- Tooling guidance

Decoration  
Products

Art  
Products

New Brand  
Products

Advertising  
Kiosks &  
Decoration  
Products

# Industrial Products



## AEROSPACE INDUSTRY / ETOPHIA

From planning to engineering, manufacturing and installation all aspects of the project can be accomplished indoor. We provide project management, engineering and design services.





PRIVATE YACHT INDUSTRY

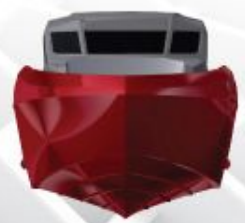
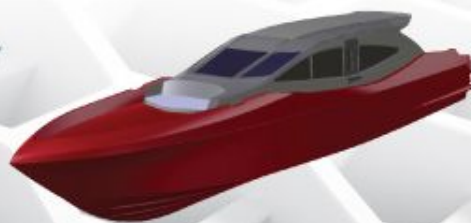

Urban  
Products





Our projects vary from small scale installations to large scaled ones. Without any discrimination towards the scale of a project, we provide the same professional service to all our customers.



Urban  
Products



SCULPTURE / ISTANBUL



BOTANIC GARDEN /  
BAKIRKOY - ISTANBUL

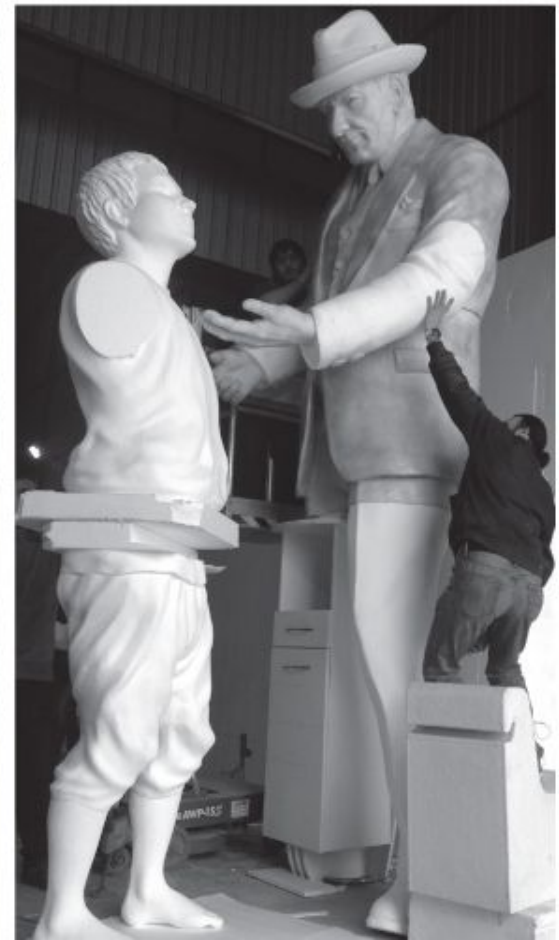





SCULPTURE / IZMIR



Our team is good at designing innovative and creative solutions to different projects. We use a multi-disciplinary approach, which makes it possible to offer flexible solutions.



ELEPHANT BARN / ISTANBUL



# Museum Concepts Designs Realizations



SomartTECH is developing and producing a very wide-range of custom-made composite products. Our competitive advantages are our expertise in high-tech production, our know-how about wide-variety raw materials and our experienced design and engineering team.



## ASHGABAD TECHNOLOGY PARK HISTORY of CIVILIZATION MUSEUM / TURKMENISTAN



Museum  
Concepts  
Designs  
Realizations



PREHISTORICAL ANIMATIONS

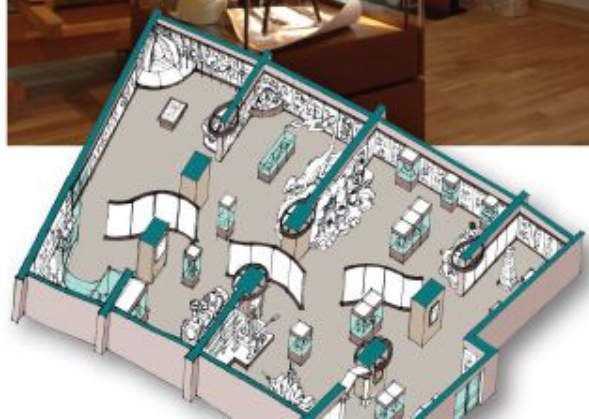
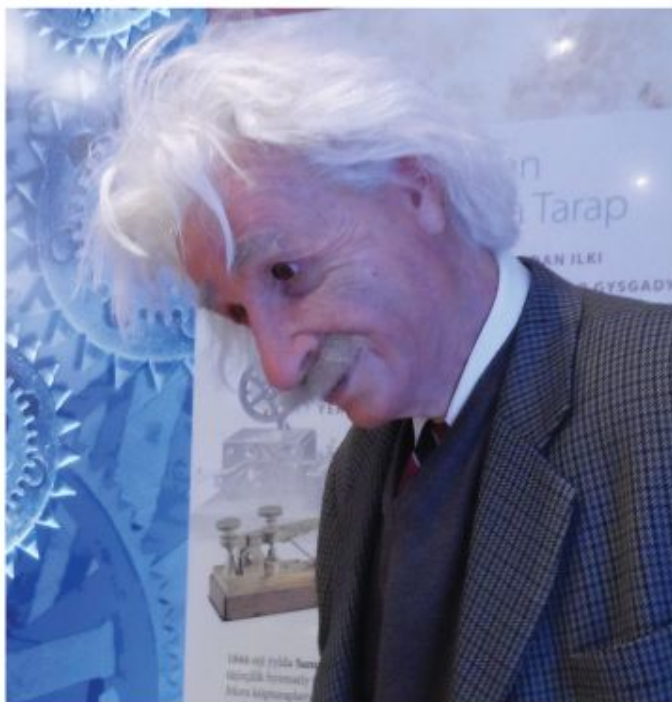

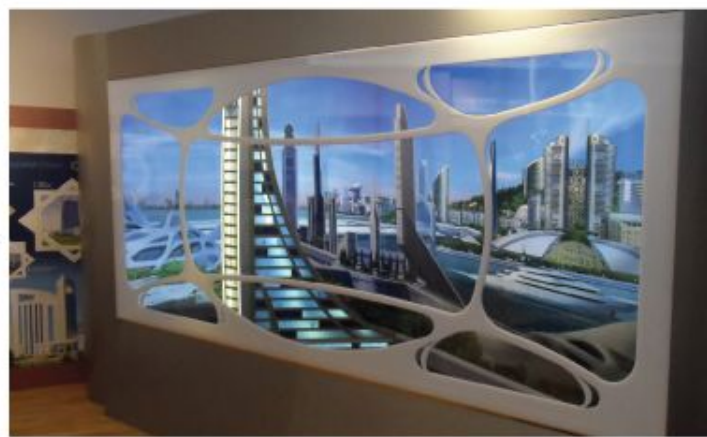

Museum  
Concepts  
Designs  
Realizations



HAREM AL SULTAN EXHIBITION  
DOHA / DUBAI

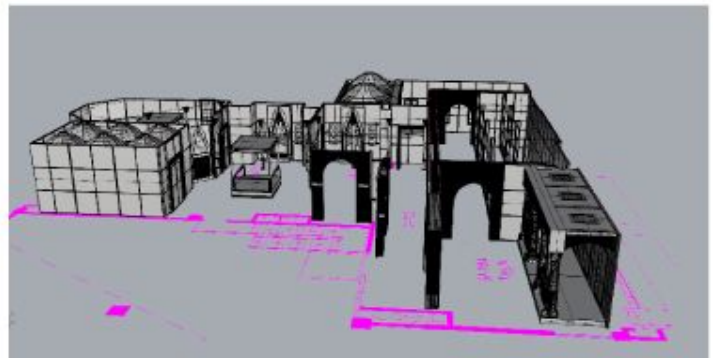

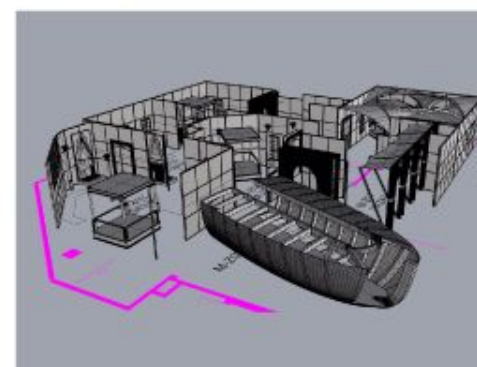
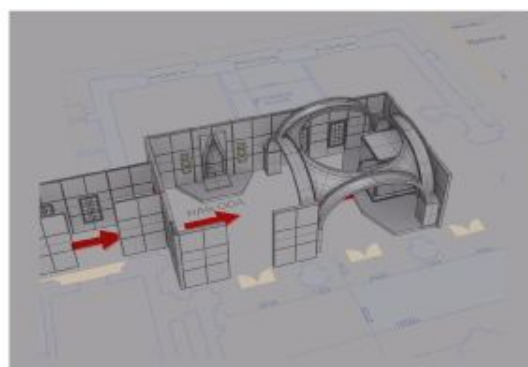
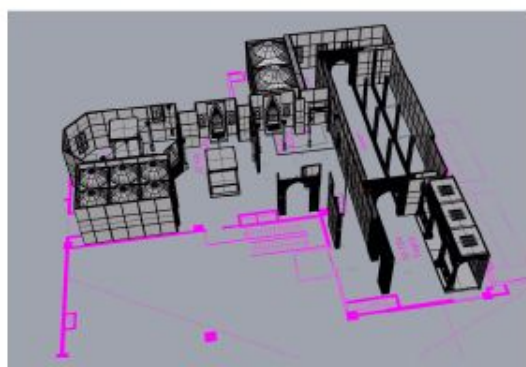
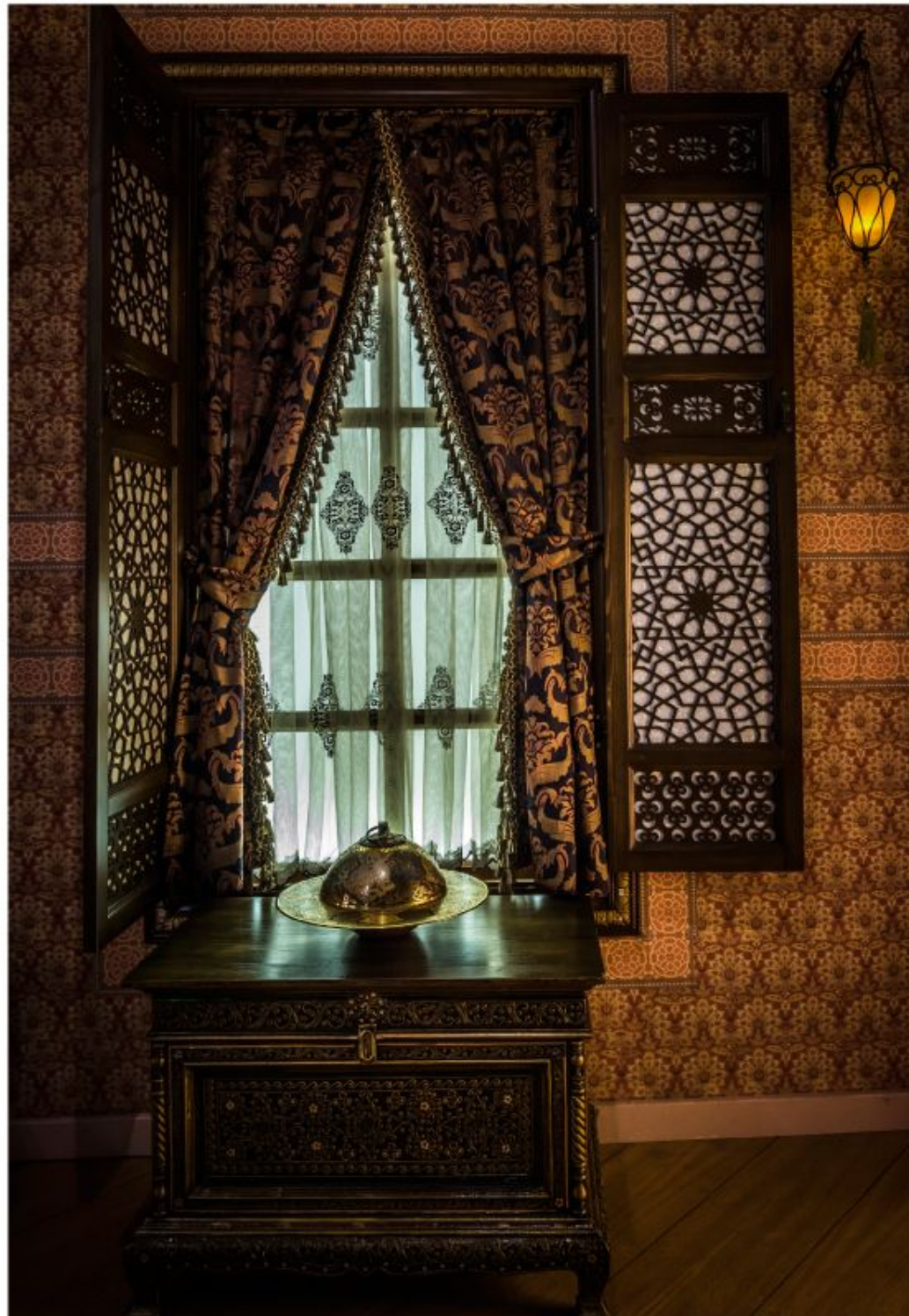

Museum  
Concepts  
Designs  
Realizations

HAREM AL SULTAN EXHIBITION  
DOHA / DUBAI







Museum  
Concepts  
Designs  
Realizations



NATIONAL QUAKE MUSEUM  
ASGAHABAT  
TURKMENISTAN



ANEV MOSQUE  
ASGAHABAT  
TURKMENISTAN



PRIVATE MUSEUM / ISTANBUL

New Generation Simulators



Hyper Realistic Experiences

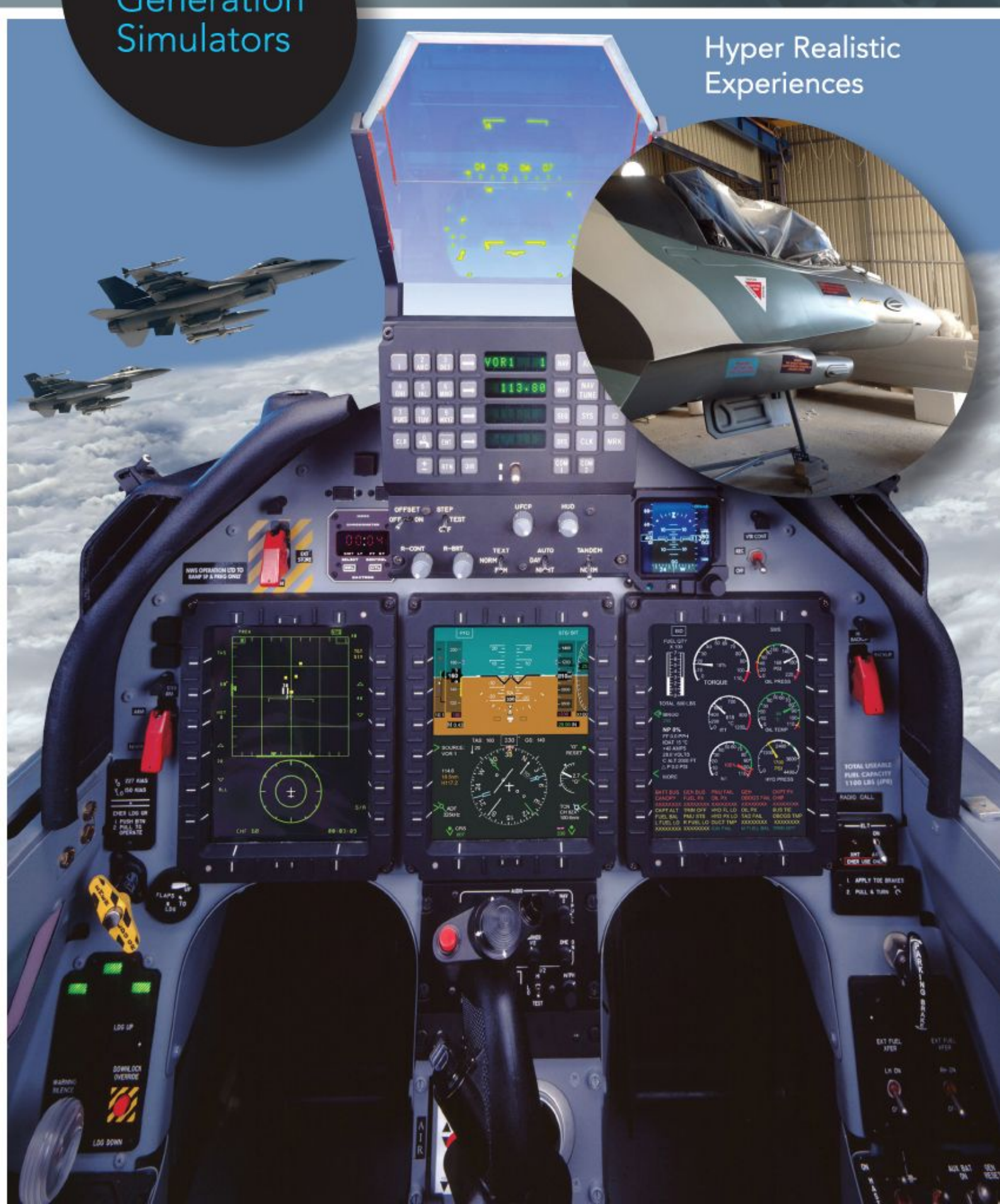

# Theme Parks Children Play Areas

**mino  
polis**  
istanbul  
ÇOCUKLARIN ŞEHİRİ



The indoor theme park is a city built to scale for children, complete with buildings, paved streets, vehicles, a functioning economy, and recognizable destinations in the form of "establishments".



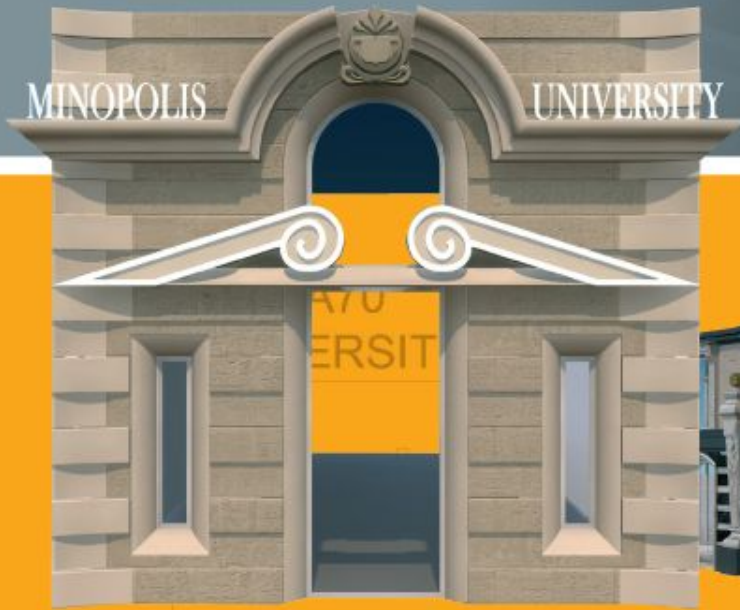

Creativity has no limits...  
And now applications  
have none too.



# Theme Parks Children Play Areas



SomartTECH offers exclusive solutions for artists and design companies, enabling them to realize their special designs and the municipalities to produce the visual objects and sculptures used in landscaping of gardens and parks; as well as solutions for production of the scenery, characters and props that the cinema and television industries require.

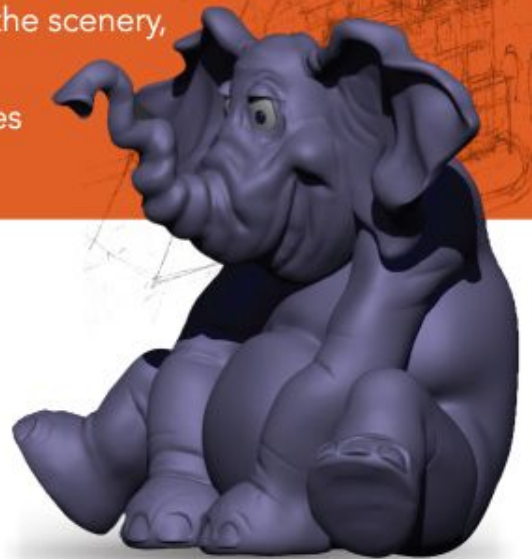



Art  
Products



SomartTECH uses art, experience, technical knowledge and technology to perform a new design in 3D.



VENICE BIENNALE (2014)





## REPLICA



### Producing Replicas of Historic Sculptures

Classical replica production requires a silicone mold to be obtained from the artifact and then perform casting with suitable casting material. This silicone mold method requires direct contact with the surface of artifact and therefore it can not be used for artifacts with flaking or paint on its surface. We use 3D optical scanner - the first in our country - to transfer the artifact to digital medium and produce its replica without damaging it. Digital data is brought to life by processing epoxy paste material with an 8-axis robot CNC machine.



# Decoration Products



ACIBADEM  
HOSPITAL

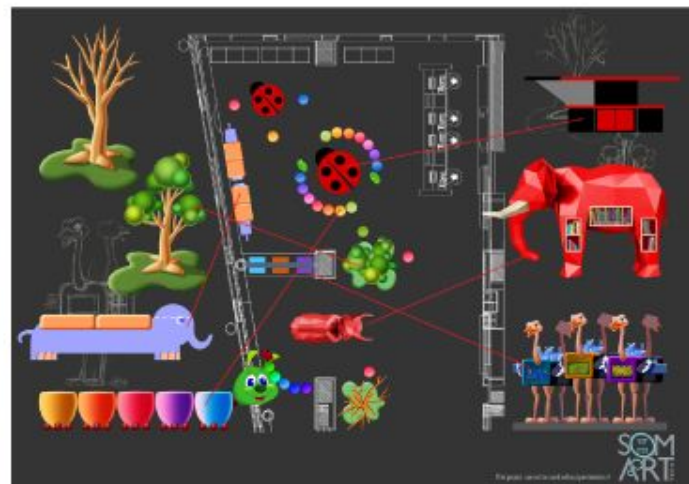
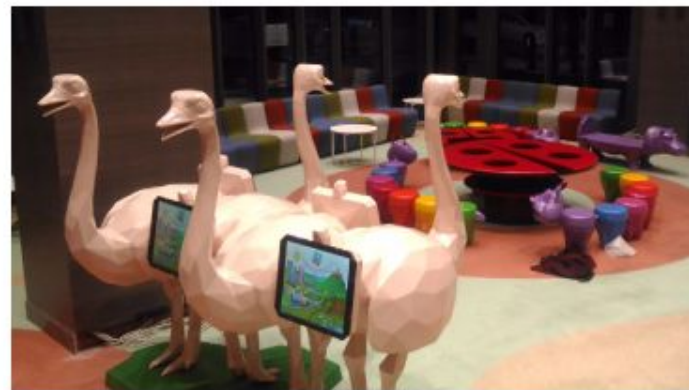

SOM  
ART



## Advertising Kiosk & Decoration Products

We create a 3D version of your products and brand elements, we can do even more with it. Our 3D advertising media can be directly integrated into your workflow.

## CAMPER NEW PRODUCT LAUNCH DECOR

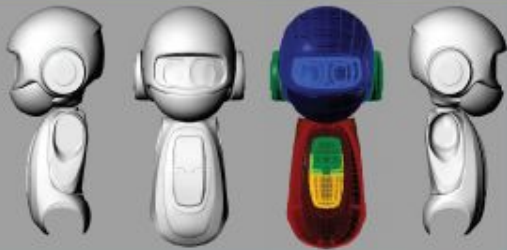

ÇELİK (by ARÇELİK)  
SALE POINT STAND



## New Brand Products

As SomartTECH, we accomplished many successful projects in the field of composites, commercial products, display sign products, animation character and the sense of touch surfaces products in a very short period of time.



MINERAL WATER BOTTLE PROTOTYPE



T40 PROTOTYPE





**SOMART Visual and Industrial Design LLC**

Istanbul Anadolu Yakası O.S.B.  
Aydınlı Mah. 7. Sokak No: 10  
34953 Tuzla, İstanbul-Türkiye

Tel. + 90 216 593 13 90  
+ 90 216 593 13 91  
+ 90 216 593 13 92

Fax. + 90 216 593 13 93  
E-mail. [info@somarttech.com](mailto:info@somarttech.com)  
[www.somarttech.com](http://www.somarttech.com)